

# Instructions for use English

## E-Safe Universal (CH)

## E-Safe Universal I (EU)

Intended use: Disposal container for sharp and pointed objects

### Waste container

0.5/0.6/1.6/2.0/3.1/7.1 litre

## Cover assembly

### Variant 1

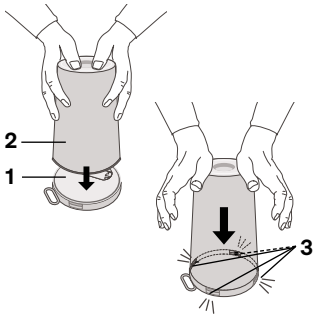

Place the lid (1) on a stable surface and place the container (2) with the opening on the lid.

Press firmly on the bottom of the container to connect it to the lid until all locking tabs (3) are visibly and audibly engaged.

### Variant 2

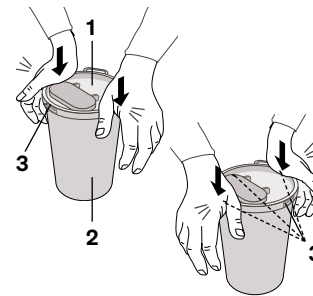

The lid (1) is placed on the container (2). By applying strong pressure at the level of the opposing locking tabs (3) ...

... the lid is connected to the container. All locking tabs (3) must be visibly and audibly locked into place.

## Lid closure

### Day and transport closure

The lid fastening is designed as a hinge and can be opened or closed as often as required. For ease of use, the lid can be folded back and fixed in a vertical position. The lid is folded onto the opening and pressed down firmly over the entire surface. The lid tab makes it easier to open the daily closure.

### Disposal closure

After filling the E-Safe container completely, fold down the lid tab (1), insert it into the closure opening (see arrow) and snap it into place (2). For the 1.6, 2.0, 3.1 and 7.1 litre containers, the lid must then be pressed in at the pressure points (3) (4) (5) until it reaches the recesses on the surrounding edge (audible click).

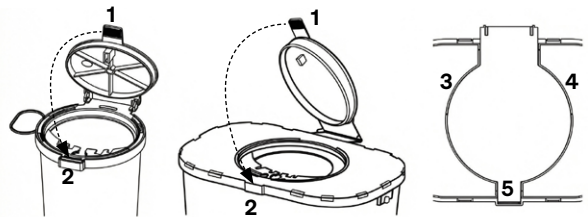

## Application

### A) Removal device for cannulas:

Different removal notches enable easy removal of cannulas.

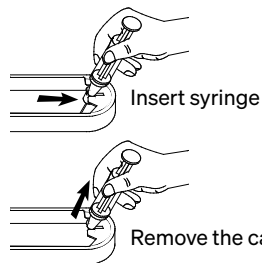

### B) Removal device for insulin pens:

The pen is released by turning it in the unscrewing opening (1) - When the daily cover is closed gently, the tab on the bottom of the cover pushes the pen out of the unscrewing ring and into the container (2).

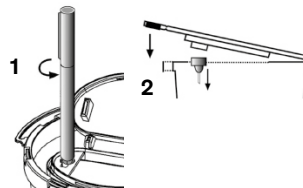

### C) Removal device for scalpel blades:

The scalpel is pressed vertically into the narrow slot (with the closed side facing forwards) (1). Applying slight pressure forwards (2) releases the blade - it falls out when the scalpel is withdrawn.

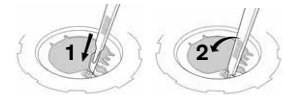

### D) Drop opening:

The generously sized opening also allows bulky items such as butterfly needles to be disposed of safely.

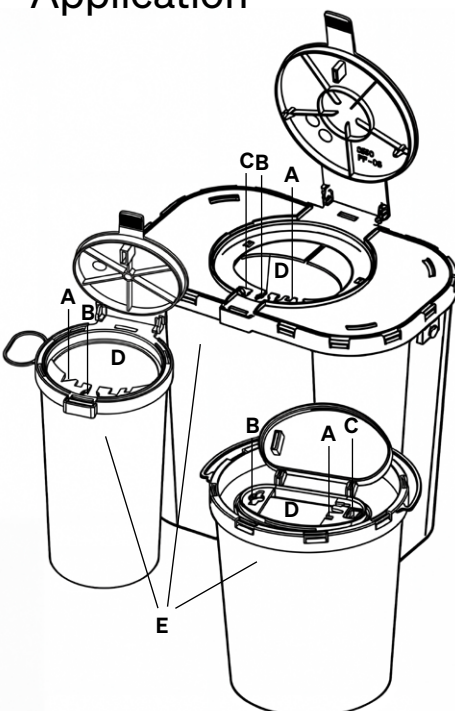

### E) Fill level label:

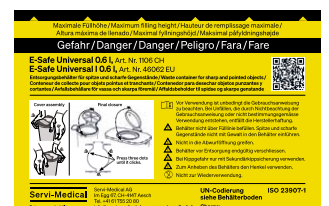

Warning notices on the reverse side →

## Applies to the following E-Safe products

Item No. CH	Item No. EU	Container ID No.	Lid ID No.	Maximum gross weight in kilograms
*	<b>46052</b>	0.5 l - yellow <b>0005</b>	transparent <b>0080</b>	0.2
<b>1106</b>	<b>46062</b>	0.6 l - yellow <b>0007</b>	transparent <b>0080</b>	0.2
*	<b>46162</b>	1.6 l - yellow <b>0045/0046</b>	transparent <b>0375</b>	0.3
*	<b>46202</b>	2.0 l - yellow <b>0051</b>	transparent <b>0375</b>	0.4
*	<b>46302</b>	3.1 l - yellow <b>0065/0066</b>	transparent <b>0375</b>	0.6
*	<b>46702</b>	7.1 l - yellow <b>0070</b>	transparent <b>0390</b>	1.5

\*Container not available in Switzerland

## Intended use

E-Safe products are intended exclusively for the disposal of needles, syringes, scalpels and broken glass from the medical sector (hazardous solid materials in packaging groups II or III). Any other use is not in accordance with the intended purpose.

## General description

E-Safe products are made of polypropylene, are tested in accordance with ISO 23907-1 and have UN approval. Manufacturing data: The month/year and identification number are printed on every E-Safe container and lid for batch traceability.







## Absorbent material, disposal and labelling

Before disposal, full E-Safe products must be checked for specific or non-specific hazardous substances and labelled by a responsible person according to their degree of hazard. Before sealing, check whether they contain any liquids. If liquids are present, the user must add a sufficient amount of absorbent material to the E-Safe products. Disposal must be carried out in accordance with the applicable legal provisions.

## Note

We reserve the right to make technical changes to the illustrations and information in these operating instructions that are necessary to improve the products.

## Safety instructions

-  It is essential to read the instructions for use before use. The manufacturer accepts no liability for accidents caused by failure to follow the instructions for use or improper use.
-  Do not fill the container above the fill line. Do not force sharp or pointed objects into the container.
-  Do not reach into the chute.
-  Seal container tightly before disposal.
-  If there is a risk of tipping, only use with secondary anti-tip protection.
-  Use the handle to lift the container.
-  Not for reuse.

## Accessories

You will receive separate instructions for use for the following items.



### Movix adhesive adapter

<b>for containers</b> <b>0.5 l - 0.6 l</b>	<b>for containers</b> <b>0.5 l - 3.1 l</b>
<b>Item No. CH: 1154</b>	<b>Item No. CH: 1155</b>
<b>Item No. EU: 46002</b>	<b>Item No. EU: 46003</b>



### Plateau pour seringues E-Tray

without bayonet lock and with bayonet lock for small and large containers

without bayonet fitting	for small containers	for small and large containers
	<b>0.5 l - 0.6 l</b>	<b>0.5 l - 3.1 l</b>
<b>Item No. CH: 1158</b>	<b>Item No. CH: 1152.KL.</b>	<b>Item No. CH: 1152</b>
<b>Item No. EU: 45000</b>	<b>Item No. UE: 45041</b>	<b>Item No. EU: 45101</b>



### Holder for containers

Mounting on wall, trolley or adapte

<b>for containers</b> <b>0.5 l - 0.6 l</b>	<b>for containers</b> <b>1.6 l - 3.1 l</b>
<b>Item No. CH: 1149</b>	<b>Item No. CH: 1150</b>
<b>Item No. EU: 45005</b>	<b>Item No. EU: 45010</b>

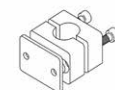

### Adapter

for attachment to the infusion stand

<b>pipe Ø 20 mm</b>	<b>pipe Ø 25 mm</b>
<b>Item No. CH: 1387</b>	<b>Item No. CH: 1388</b>
<b>Item No. EU: 45020</b>	<b>Item No. EU: 45025</b>

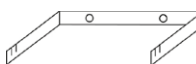

**E-Safe wall bracket** only for 7.1 litre containers for mounting on walls or trolleys

**Item No. CH: 1157**  
**Item No. EU: 45030**

